

70 WATTS

SINGLE/MULTI OUTPUT AC-DC

FEATURES:

- Compact 2.5 x 4.5" x 1.2" Size
- 2 Year Warranty
- Universal 85-264V Input
- One to Four Outputs
- High Efficiency
- 0-70°C Operating Temperature
- IEC 60601-1 3rd ed. Medical Cert.
- IEC 62368-1 2nd Certification
- IEC 60601-1-2 4th ed. EMC
- Class B Emissions per EN55011/32
- RoHS Compliant
- Optional Chassis/Cover







CHASSIS/COVER



OPEN FRAME

SAFETY SPECIFICATIONS

	Underwriters Laboratories File E137708/E140259	UL 60950-1:2007, 2 nd Edition AAMI/ANSI ES60601-1:2005/(R) 2012
		CB Reports/Certificates (including all National and Group Deviations) IEC 62368-1:2014, 2 nd Edition IEC 60601-1:2005/A1:2012
	UL Recognition Mark for Canada File E137708/E140259	CAN/CSA-C22.2 No. 60950-1-07, 2 nd Edition CAN/CSA-C22.2 No. 60601-1:2014
	TUV	EN 62368-1:2014, 2 nd Edition EN 60601-1:2006/A1:2013
	Low Voltage Directive RoHS Directive (Recast)	(2014/35/EU of February 2014) (2011/65/EU of June 2011)

MODEL LISTING

MODEL NO.	OUTPUT 1	OUTPUT 2	OUTPUT 3	OUTPUT 4
REL-70-4001	+3.3V/6A	+5V/5A	+12V/2A ⁽²¹⁾	-12V/2A ⁽²¹⁾
REL-70-4002	+5V/6A	+3.3V/5A	+12V/2A ⁽²¹⁾	-12V/2A ⁽²¹⁾
REL-70-4003	+5V/6A	+3.3V/5A	+15V/2A ⁽²¹⁾	-15V/2A ⁽²¹⁾
REL-70-4004	+5V/6A	-5V/5A	+12V/2A ⁽²¹⁾	-12V/2A ⁽²¹⁾
REL-70-4005	+5V/6A	-5V/5A	+15V/2A ⁽²¹⁾	-15V/2A ⁽²¹⁾
REL-70-4006	+5V/6A	+24V/2A	+12V/2A ⁽²¹⁾	-12V/2A ⁽²¹⁾
REL-70-4007	+5V/6A	+24V/2A	+15V/2A ⁽²¹⁾	-15V/2A ⁽²¹⁾
REL-70-4009	6.7V/5A	5V/4A	+15V/2A ⁽²¹⁾	-15V/2A ⁽²¹⁾
REL-70-3001	+5V/6A	+12V/2A		-12V/2A ⁽²¹⁾
REL-70-3002	+5V/6A	+15V/2A		-15V/2A ⁽²¹⁾
REL-70-3003	+5.1V/6A	+7.5V/2A		-7.5V/2A ⁽²¹⁾
REL-70-3004	+3.3V/6A	+7V/5A	+12V/2A ⁽²¹⁾	
REL-70-2001	+3.3V/6A	+5V/5A		
REL-70-2002	+5V/6A	+12V/4A		
REL-70-2003	+5V/6A	+24V/2A		
REL-70-2004	+12V/3A	-12V/3A		
REL-70-2005	+15V/3A	-15V/2A		
REL-70-2006	+5.5V/6A	-5.5V/5A		
REL-70-1001	2.5V/14A ⁽²⁰⁾			
REL-70-1002	3.3V/14A ⁽²⁰⁾			
REL-70-1003	5V/14A ⁽²⁰⁾			
REL-70-1004	12V/5.8A			
REL-70-1005	15V/4.7A			
REL-70-1006	24V/2.9A			
REL-70-1007	28V/2.5A			
REL-70-1008	48V/1.5A			

ORDERING INFORMATION

Consult factory for alternate output configurations.
Consult factory for positive, negative or floating outputs.
Please specify the following optional features when ordering:

CH - Chassis I/O - Isolated Outputs
CO - Cover TS - Terminal Strip

REL-70

OUTPUT SPECIFICATIONS

Total Output Power at 50°C ₍₁₎ (See Derating Chart)	50W 70W	Convection Cooled ⁽¹⁶⁾⁽¹⁸⁾ 300LFM Forced-Air Cooled ⁽¹⁵⁾⁽¹⁷⁾⁽¹⁹⁾
Output Voltage Centering	Output 1: Output 2,3,4:	± 0.5% (All outputs at 50% load) ± 5.0%
Output Voltage Adjust Range	Output 1:	95 - 105%
Load Regulation	Output 1: Output 2: (4001-5) (2001) Output 3: Output 4:	0.5% (10-100% load change) 5.0% 8.0% 8.0% 5.0% 5.0%
Source Regulation	Outputs 1 - 4:	0.5%
Cross Regulation	Outputs 2 - 4:	5.0%
Output Noise	Outputs 1 - 4:	1.0%
Turn on Overshoot		None
Transient Response	Outputs 1 - 4	
Voltage Deviation		5.0%
Recovery Time		500µS
Load Change		50% to 100%
Output Overvoltage Protection	Output 1:	110% to 150%
Output Overpower Protection		110-160% rated Pout, cycle on/off, auto recovery
Hold Up Time		16mS min., Full Power, 85V Input
Start Up Time		4 Seconds, 120V Input

INPUT SPECIFICATIONS

Protection Class	I
Source Voltage	85 - 264 Volts AC
Frequency Range	47 - 63 Hz
Peak Inrush Current	40A
Efficiency	78% Typ., Full Power, 230V, varies by model
Power Factor	0.95 (Full Power, 230V)

ENVIRONMENTAL SPECIFICATIONS

Ambient Operating	0°C to + 70°C
Temperature Range	Derating: See Power Rating Chart
Ambient Storage Temp. Range	-40°C to + 85°C
Temperature Coefficient	Outputs 1 - 4: 0.02%/°C

GENERAL SPECIFICATIONS

Means of Protection	
Primary to Secondary	2MOPP (Means of Patient Protection)
Primary to Ground	1MOPP (Means of Patient Protection)
Secondary to Ground	Operational Insulation(Consult factory for 1MOPP)
Dielectric Strength ^(8, 9)	
Reinforced Insulation	5656 VDC, Primary to Secondary
Basic Insulation	2121 VDC, Primary to Ground
Operational Insulation	707 VDC, Secondary to Ground
Leakage Current	
Earth Leakage	<300µA NC, <1000µA SFC
Touch Current	<100µA NC, <500µA SFC
Power Fail Signal ⁽¹⁴⁾	Logic low with input power failure 10 ms minimum prior to Output 1 dropping 1%
Remote Sense (singles only) ⁽¹⁰⁾	250mV compensation of output cable losses
Mean-Time Between Failures	100,000 Hours min., MIL-HDBK-217F, 25° C, GB
Weight	0.60 Lbs. Open Frame 1.00 Lbs. Chassis and Cover

EMC SPECIFICATIONS (IEC 60601-1-2:2014, 4TH ED./IEC 61000-6-2:2005)

Electrostatic Discharge	EN 61000-4-2	±8KV contact / ±15KV air discharge	A
Radiated Electromagnetic Field	EN 61000-4-3	80MHz-2.7GHz, 10V/m, 80% AM	A
Electrical Fast Transients/Bursts	EN 61000-4-4	±2 KV, 5KHz/100KHz	A
Surge Immunity	EN 61000-4-5	±2 KV line to earth / ±1 KV line to line	A
Conducted Immunity	EN 61000-4-6	0.15 to 80MHz, 10V, 80% AM	A
Magnetic Field Immunity	EN 61000-4-8	30A/m, 60 Hz.	A
Voltage Dips	EN 61000-4-11	0% U _T , 0.5 cycles, 0-315° 0% U _T , 1 cycles, 0° 40% U _T , 10/12 cycles, 0° 70% U _T , 25/30 cycles, 0°	100/240V A/A 100/240V A/A 100/240V B/A 100/240V B/A
Voltage Interruptions	EN 61000-4-11	0% U _T , 300 cycles, 0°	100/240V B/B
Radiated Emissions	EN 55011/32	Class B	
Conducted Emissions	EN 55011/32	Class B	
Harmonic Current Emissions	EN 61000-3-2	Class A	
Voltage Fluctuations/Flicker	EN 61000-3-3	Compliant	

All specifications are maximum at 25°C/70W unless otherwise stated, may vary by model and are subject to change without notice.



REL-70 MECHANICAL SPECIFICATIONS

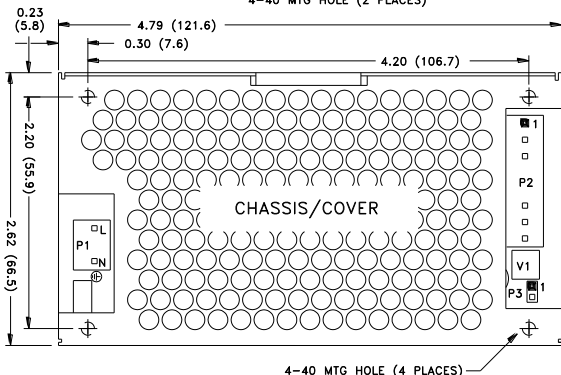
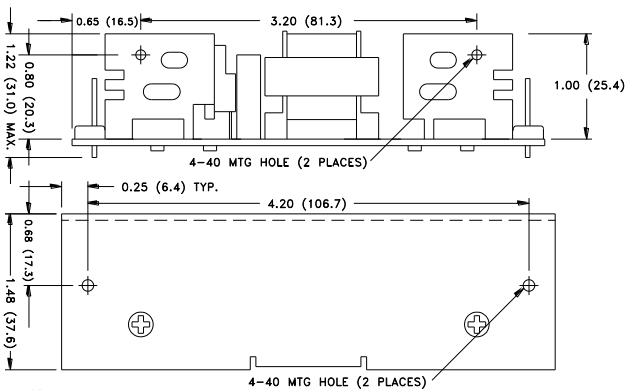
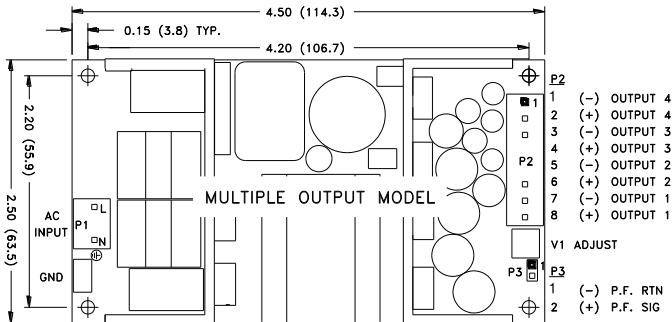
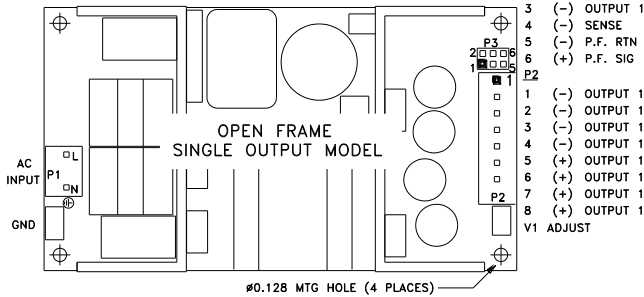
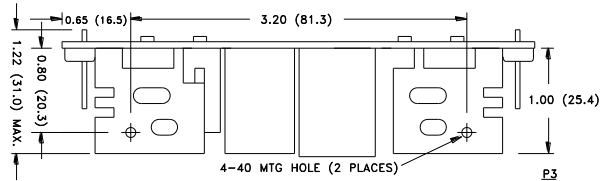

ALL DIMENSIONS IN INCHES (mm)

APPLICATIONS INFORMATION

- Each output can deliver its rated current but Total Output Power must not exceed 70W, as determined by the cooling method.
- Generally, adequate cooling is provided when semiconductor case temperatures do not exceed 70°C rise and transformer temperature does not exceed 60°C rise at any specified ambient temperature.
- Sufficient area must be provided around power supply to allow natural movement of air to develop in convection-cooled applications.
- This product is intended for use as a professionally-installed component within information technology, industrial, and medical equipment and is not intended for stand-alone operation.
- A minimum load of 10% is required on Output 1 to ensure proper regulation of remaining outputs.
- This product includes only one fuse in the input circuit. In consideration of Clause 8.11.5 of IEC 60601-1:2005, a second fuse may be required in the end product.
- Peak-to-Peak Output Ripple and Noise is measured directly at the output terminals of the power supply, without the use of the probe ground lead or retractable tip (tip-and-barrel method), 20 MHz bandwidth.
- This product was type-tested and safety-certified using the dielectric strength test voltages listed in Table 6 of IEC 60601-1:2005. In consideration of Clause 8.8.3, care must be taken to insure that the voltage applied to a reinforced insulation does not overstress different types and levels of insulation. Primary and secondary-to-ground capacitors may need to be disconnected prior to performing a dielectric strength test on the power supply or the end product. It is highly recommended that the DC test voltages listed in DVB.1, Annex DVB of UL 60601-1 1st Edition are not exceeded during a production-line dielectric strength test of the assembled end product. Please consult factory for further information.
- This power supply has been safety-approved and final-tested using a DC dielectric strength test. Please consult factory before performing an AC dielectric strength test.
- Remote-Sense terminals may be used to compensate for cable losses up to 250mV (single output models only). The use of a twisted pair, decoupling capacitors and an appropriately-rated low-impedance capacitor connected across the load will increase noise immunity.
- Maximum screw penetration into bottom chassis mounting holes is 0.100 inches. Maximum screw penetration into side chassis mounting holes is 0.250 inches.
- To comply with emissions specifications, all four mounting hole pads must be electrically connected to a common metal chassis. Chassis/Cover option is recommended. Refer to Operating Instructions for additional information.
- Common RF shielding precautions may need to be taken to assure emissions compliance. Refer to Operating Instructions for additional information.
- Power-Fail (AC-Good) feature provides a logic-low warning signal from an open collector transistor output 10ms prior to loss of output from AC failure, 5V/10mA.
- 300LFM minimum of airflow must be maintained one inch above all points of top-side components or cover when forced-air cooling is required.
- Total power must not exceed 50W with convection cooling on open-frame models.
- Total power must not exceed 70W with 300LFM forced-air cooling on open-frame models.
- Total power must not exceed 40W with convection cooling and Chassis/Cover option.
- Total power must not exceed 70W with 300LFM forced-air cooling and Chassis/Cover option.
- Rated 10A with convection cooling.
- Rated 1.5A with convection cooling.

MAXIMUM OUTPUT POWER vs. AMBIENT TEMPERATURE

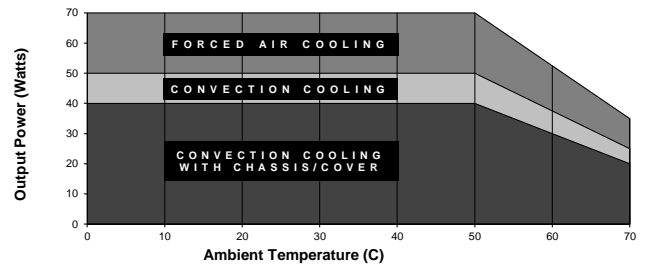

CONNECTOR SPECIFICATIONS

P1	AC Input	0.156 friction lock header mates with Tyco 640250-3 or equivalent crimp terminal housing with Tyco 3-640706-1 or equivalent crimp terminal.
P2	DC Output (Single)	0.156 friction lock header mates with Tyco 770849-8 or equivalent crimp terminal housing with Tyco 3-640707-1 or equivalent crimp terminal.
P2	DC Output (Multiple)	0.156 friction lock header mates with Tyco 770849-8 or equivalent crimp terminal housing with Tyco 3-640707-1 or equivalent crimp terminal.
G	Ground	0.187 quick disconnect terminal.
P3	P.F./Sense (Single)	0.100 breakaway header mates with Molex 22-55-2061 or equivalent crimp terminal housing with Molex type 71851 or equivalent crimp terminal.
P3	Power Fail (Multiple)	0.100 breakaway header mates with Molex 50-57-9002 or equivalent crimp terminal housing with Molex type 71851 or equivalent crimp terminal.

REV. R 08/27/2020